

INSTALLATION GUIDE

Magnetostrictive Sensor Series MAB

For more information please see the data sheet at
www.waycon.biz/products/magnetostrictive-transducers/

FIRST STEPS

WayCon Positionsmesstechnik GmbH would like to thank you for the trust you have placed in us and our products. This manual will make you familiar with the installation and operation of our magnetostrictive sensors. Please read this manual carefully before initial operation!

Unpacking and checking:

Carefully lift the device out of the box by grabbing the housing. After unpacking the device, check it for any visible damage as a result of rough handling during the shipment. Check the delivery for completeness.

If necessary consult the transportation company, or contact WayCon directly for further assistance.

GENERAL NOTES

The transducer must be installed away from sources of magnetic fields, both static and dynamic. The connection cable must be wired separately from power cables and/or solenoid controls, drives, or remote switches. The line used for power supply must be dedicated to the transducers or must be drawn directly from the power terminals and as near as possible. When choosing a cursor for the MAB profile, remember that the transducer's cursor is a magnet. Therefore, if there are iron filings or small magnetic metal fragments in proximity of the transducer, avoid the use of sliding cursors, as there would be a risk of material accumulation on the cursor, creating problems for sliding. Use a floating cursor instead.

MAGNETIC CURSORS

Magnetic Cursors (please order separately)

Cursors for MAB-A / MAB-S	Cursors for MAB-C	Description
PCUR210	PCUR045	standard version; guided sliding, axial joint, low
PCUR211	PCUR046	guided sliding, axial joint, high
PCUR212	PCUR047	guided sliding, angled joint
PCUR202	PCUR068	unguided floating ¹⁾

PCUR210
PCUR045



PCUR212
PCUR047

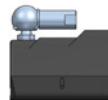

PCUR211
PCUR046



PCUR202
PCUR068



¹⁾ The adjustment has to be done 2...7 mm above the MAB-profile. Allowed lateral deviation ± 2 mm. Installation only on a support made of non-magnetic material.

MOUNTING THE SENSOR

Brackets (please order separately)

1 set includes 2 brackets. We recommend to use 1 set for each 250...300 mm of the measurement range.

Code: PKIT091

Material: steel

Overall length: 63.5 mm

Distance between mounting holes: 50 mm

Mounting screws: M5

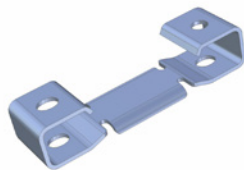

Sliding magnetic cursor

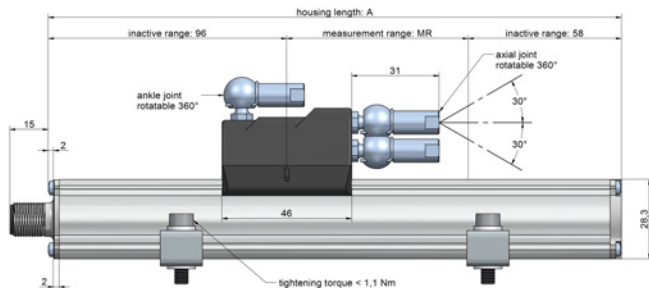
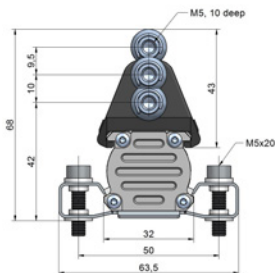

Floating magnetic cursor

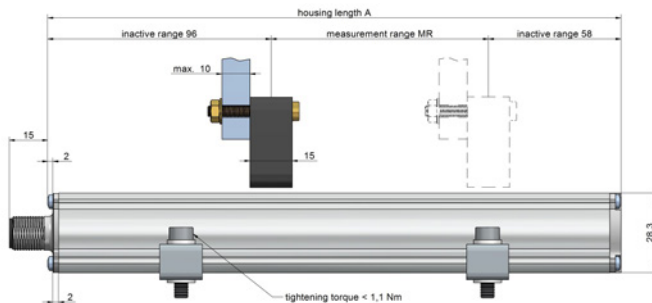
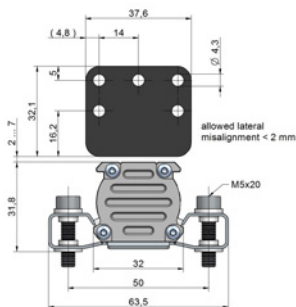

A	[mm]	measurement range + 154
---	------	-------------------------

During installation, please observe the magnetically inactive range before and after the measurement range. The inactive range is 96 mm on the connector side and 58 mm on the front side.

ELECTRICAL CONNECTION

The transducer case must be grounded with the cable sheathing on the control system side only.

MAB-A: analog output

Supply: 24 VDC, $\pm 20\%$

Function	Pin
Output magnetic cursor 1	1
GND output magnetic cursor 1, 2, speed	2
Inverse output:	
Output magnetic cursor 2, speed	3
Supply GND	4
Supply +	5

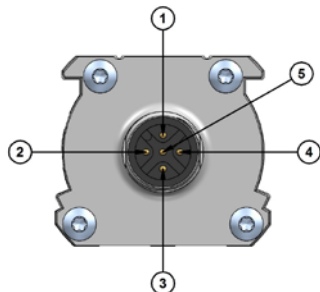

Connection cable analog output

Cable with mating connector M12, female, 5 pins, IP67

K5PXM-S-M12 X m, straight connector, shielded

K5PXM-SW-M12 X m, angular connector, shielded

Pin	1	2	3	4	5
Cable colour	BN	WH	BU	BK	GY

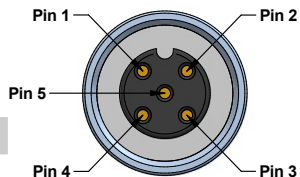

MAB-C: digital output CANopen

Supply: 24 VDC, $\pm 20\%$

Baud rate: 500 kBaud

Interface: CANopen DS-301 V4.01

Device profile: DS-406 V2.0

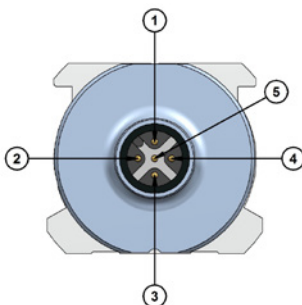

Function	Pin
n. c.	1
Supply +	2
Supply GND	3
CAN H	4
CAN L	5

CANopen Data Protocol

SOF	Arbitration	Control	Data Field	CRC	ACK	EOF	Interframe Space
1	11	1	6	0..8 Bytes	15	1 1 1	7
							≥ 3 Bits
Type	Cursors	PD01 (Standard)			PD02 (Standard)		
A	1	Position 4 Byte integer Speed 2 Byte integer Cams, 1 Byte integer			Absence of data		
B	2	Position 4 Byte integer Speed 2 Byte integer Cams, 1 Byte integer			Position 4 Byte integer Speed 2 Byte integer Cams, 1 Byte integer		

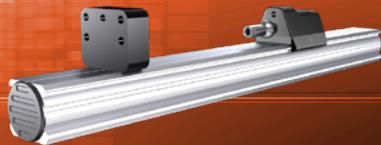

ELECTRICAL CONNECTION

MAB-S: digital output SSI

Supply: 10...32 VDC

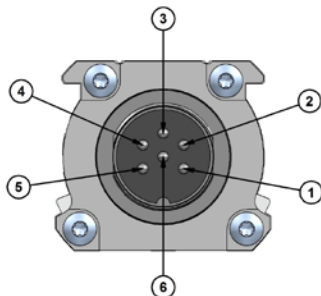

Function	Pin
Data -	1
Data +	2
Clock +	3
Clock -	4
Supply +	5
Supply GND	6

DECLARATION OF EU-CONFORMITY

WayCon Positionsmesstechnik GmbH
Mehlbeerenstrasse 4
82024 Taufkirchen / Germany

This is to certify that the products

Classification
Series

Magnetostrictive Sensors
MAB

fulfill the current request of the following EU-directives:

EMV-directive 2004/108/EG (until April 19th 2016)
2014/30/EU (from April 20th 2016)

applied harmonized standards:

EN 61000-6-2:2005, EN 61000-6-4:2007, EN 61326-1:2006

The declaration of conformity loses its validity if the product is misused or modified without proper authorisation.

Taufkirchen, 24.02.2016

Andreas Täger
CEO